



In-Home Warranty

## 1320MM NEW GENERATION INDOOR - OUTDOOR CEILING FAN



The Beret is a quality made 1320mm precision designed moulded ABS 12° degree blade system designed for high air movement, and is ideal for tropical rated designed for coastal outdoor applications.

- Aero-dynamic body & blade design
- Non-rusting / anti corrosive
- 3 Speed wall controller and light switch
- AC motor
- Quick connect
- Remote control adaptable (sold seperately - MPAPP remote control)



Energy Saving



Low Noise



Indoor Outdoor



Tropical Rated



Summer Winter



High Air Movement

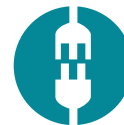

Quick Connect



30° Hang-Sure Canopy



Natural Breeze

### INCLUDES

- 1 x Ceiling fan (with or without LED light)
- 1 x 3 speed wall remote controller and light switch
- 1 x Sure-hang bracket
- 1 x Instruction manual
- 1 x Hardware pack

### AVAILABLE EXTRAS

Remote control (model MPAPP)

### DIMENSIONS

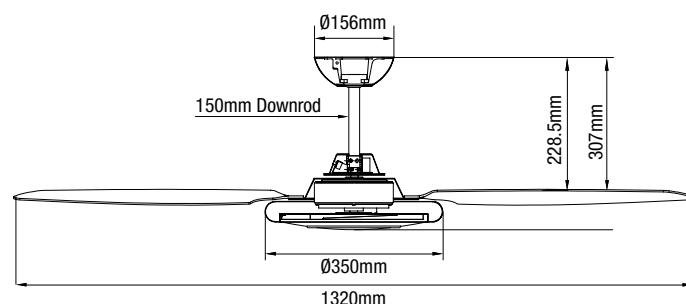

## 1320MM NEW GENERATION INDOOR - OUTDOOR CEILING FAN

### FEATURES

- Premium long life AC motor and components.
- Latest ceiling fan technology and design.
- Excellent air circulation and natural cooling effect.
- All plastic components are moulded with the great precision.
- Light weight pre balanced blades that consume less energy and produce better airflow.
- Low noise making the fan ideal for bedrooms.
- UV resistant for longevity.
- ABS blades/steel fan construction.
- Non-rusting and anti-corrosive, making it suitable for indoor/ covered outdoor use.
- Tropical and dust/splash-proof rated.
- Motor winding is pure copper.
- Motor lamination is made of high-grade electrical silicon steel for efficient and trouble free performance.
- Motor is assembled in a computerised production line with closely monitored testing to 100%, eliminate any performance issues such as unwanted wobbling.
- Reversible airflow option for summer or winter.
- Quick connect wiring and fittings for easy installation.
- Hang-sure vibration and noise reducing canopy to suit up to 30° ceiling rake pitch.
- Includes 3 speed wall controller with light switch.
- 24W tricolour LED light kit with step dimming function (fitted LED light models only - MBF1343TS, MBF1343WS).
- Designed for high air flow capacity.
- 2 year in-home warranty.

### INSTALLATION

<b>Suitable for:</b>	Outdoor and coastal applications
<b>Power input:</b>	230~240V ~50Hz
<b>Quick connect</b>	Yes
<b>Installation</b>	Certified licensed electrician required
<b>Warranty</b>	2 years in-home

### SPECIFICATIONS









<b>Model name</b>	Beret
<b>Model numbers</b>	MBF134TS, MBF134WS (no light) MBF1343TS, MBF1343WS (with LED Light)
<b>Colours available</b>	Titanium satin, white satin
<b>Warranty</b>	2 years in-home
<b>Size</b>	1320mm (52")
<b>Fan drop</b>	320mm
<b>Blade count</b>	4 - non-corrosive
<b>Blade material</b>	ABS
<b>Motor type</b>	Ball bearing
<b>Motor watt</b>	65w AC
<b>Reverse mode</b>	Yes
<b>Wall control</b>	3 Speed wall controller with light switch
<b>Voltage</b>	230~240V ~ 50Hz
<b>Size</b>	1320mm or 52" sweep blade length
<b>Blade pitch</b>	12° degree
<b>Current power wattage by speed control</b>	Speed 1: 60w - 170rpm Speed 2: 30w - 110rpm Speed 3: 20w - 70rpm
<b>Air movement capacity</b>	200m³/min or 12,000m³/hr
<b>Tricolour Switchable Light</b>	3000k, 4000k, 5000k: Up to 2000lm
<b>CRI</b>	>80

### SHIPPING

<b>Packaging size</b>	565x285x189mm
<b>Gross weight</b>	5Kg
<b>Pallet qty</b>	40 Pieces



### AVAILABLE IN TWO COLOURS WITH OR WITHOUT LED LIGHT

					
Titanium Satin	White Satin	Titanium Satin	White Satin		
Model	Colour	Barcode	Model	Colour	Barcode
MBF134TS	Titanium Satin	 9312375902164	MBF1343TS	Titanium Satin	 9312375902188
MBF134WS	White Satin	 9312375902157	MBF1343WS	White Satin	 9312375902171