

Diffused Batten (IP20) Installation Guide

We strongly recommend that you read this manual carefully before installation.
Installation MUST be carried out by a qualified and licensed electrician.



Replacement
Warranty

Models Parameters

TLDB34620	20W IP20 600mm Tricolour LED Batten White
TLDB34620S	20W IP20 600mm Tricolour LED Batten Microwave Sensor White
TLDB34640	40W IP20 1200mm Tricolour LED Batten White
TLDB34640S	40W IP20 1200mm Tricolour LED Batten Microwave Sensor White

Installation Instructions

Step 1

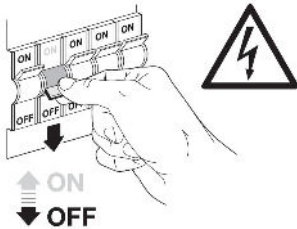

Disconnect mains supply before installation.

Step 2

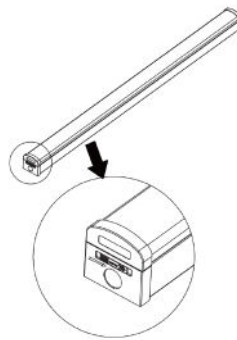

Push the switch on the end caps on both sides to open the cover of the fitting.

Step 3

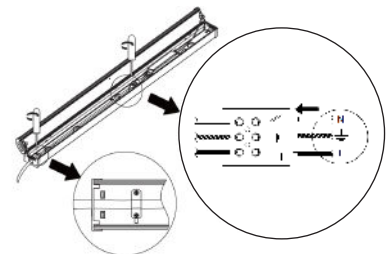

Loosen the cable clips with a screwdriver. Connect it to the terminal block and tighten the screws.

Step 4

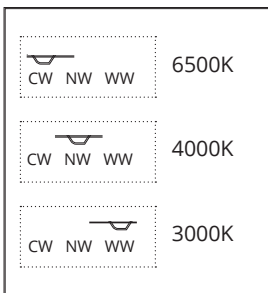

Choose colour temperature by flicking the switch.

Step 5

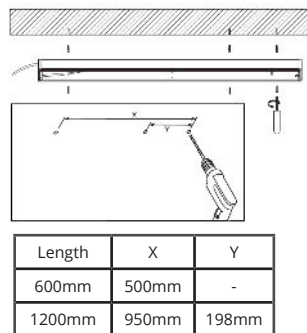

Follow the measurement table above to mark and install the fitting.

Step 6

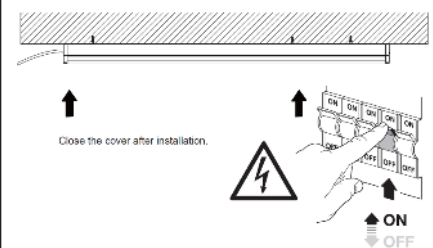

Turn ON the main power.

Diffused LED Batten (IP20) Installation Guide

Data Table

Models	Power (W)	PF	CCT (K)	Weight (KG)	Operation Temperature (Degree)	IP	IK	In-rush Current (A)	Earth Leakage Current (mA)
TLDB34620	20	>0.9	3000 4000 6500	1.5	-20° to 40°	20	-	<20	<0.7
TLDB34620S	20	>0.9	3000 4000 6500	1.5	-20° to 40°	20	-	<20	<0.7
TLDB34640	40	>0.9	3000 4000 6500	2	-20° to 40°	20	-	<20	<0.7
TLDB34640S	40	>0.9	3000 4000 6500	2	-20° to 40°	20	-	<20	<0.7

Sensor Settings

 Switch On

 Switch Off

Sensitivity

Sensitivity can be adjusted by selecting the combination on the switches for different applications.

1

 = 100%

 = 50%

Hold-time

Hold time refers to the time period that the light remains 100% on if no movement is detected.

2 3

 = 5s

 = 90s

 = 5min

 = 15min

Daylight Threshold

Different daylight threshold can be preset on switches. Light will remain ON if daylight sensor is disable.

4 5

 = Disable

 = 50Lux

 = 20Lux

 = 5Lux

Stand-by Time

This is the time period that the light remains at a low level before it is completely turned off.

6 7

 = 0s

 = 10s

 = 10min

 = +∞

Stand-by Dimming Level

Light can be dimmed to different levels after hold-time.

8

 = 10%

 = 30%

WARNING

- Installation of product **MUST** follow SAA standards and meet local authority regulations.
- Installation **MUST** be carried out by a qualified and licensed electrician.
- Light **MUST** be earthed.
- Light **MUST** be firmly installed to a flat solid surface, wall or ceiling.
- **DO NOT** immerse any part of the light fitting into water or any form of liquid.
- **DO NOT** look directly into the LED light.
- The warranty is **VOID** if product is not installed according to this installation guide.

2 Year Replacement Warranty

Visit our website for details <https://www.martecaustralia.com.au/warranty-statement/>

